



A CLEAR-COM COMPANY

Mentor CX
Mentor Automatic Changeover
User Guide

ISSUE 1.7

TRILOGY COMMUNICATIONS LIMITED
2000 Beach Drive
Cambridge Research Park
Cambridge CB25 9TP
United Kingdom
www.trilogycomms.com

The Copyright of the information and drawings in this document is the property of Trilogy Communications Limited and is neither to be reproduced in whole or in part, nor disclosed to a third party, without the prior written consent of Trilogy Communications Limited.

The information in this document has been carefully compiled and checked for accuracy. However, Trilogy Communications Limited accepts no responsibility for inaccuracies that may occur and, further, reserves the right to make changes to specification or design without prior notice.

Comments or correspondence concerning this manual should be addressed to the Publications Manager at the address given at the front of this User Guide.

DOCUMENT NUMBER

33190600

ISSUE 1.7

Issue	Date	Reason for Change
1.0	29 October 2018	Initial release
1.4	18 September 2020	331-00-01
1.5	12 March 2021	Regulatory compliance
1.6	29 April 2021	Safety information updated
1.7	21 June 2021	PSU door warning

CONTENTS

- 1. APPLICATION 5**
 - 1.1 INTRODUCTION 5
 - 1.2 VECTOR - BROWSER-BASED MANAGEMENT 5
 - 1.3 RELATED DOCUMENTS..... 5
 - 1.4 AVAILABLE FEATURES AND OPTIONS 6
- 2. INSTALLATION 7**
 - 2.1 IMPORTANT SAFETY INFORMATION..... 7
 - 2.2 UNPACKING 8
 - 2.3 RACK MOUNTING 8
 - 2.4 POWER SUPPLIES..... 8
 - 2.5 BATTERY 8
 - 2.6 REAR PANEL CONNECTIONS..... 9
 - 2.7 CHANNEL INPUT AND OUTPUT 10
 - 2.8 AES AND LTC IN FROM SPG A AND B..... 10
 - 2.9 AES AND LTC OUT..... 11
 - 2.10 FAULT LOOP 11
 - 2.11 GPI IN AND OUT 12
 - 2.12 ETHERNET 13
- 3. OPERATION 14**
 - 3.1 INTRODUCTION 14
 - 3.2 FRONT PANEL 15
 - 3.3 CONTROLS..... 16
 - 3.4 INDICATORS..... 17
- 4. USING VECTOR | BROWSER-BASED MANAGEMENT 18**
 - 4.1 INTRODUCTION 18
 - 4.2 GETTING STARTED..... 18
 - 4.3 TOP LEVEL MENU 19
 - 4.4 VECTOR | STATUS..... 20
 - 4.4.1 *Vector | Status | Overview* 20
 - 4.4.2 *Vector | Status | Channels*..... 21
 - 4.4.3 *Vector | Status | Options*..... 22
 - 4.4.4 *Vector | Status | Network*..... 22
 - 4.4.5 *Vector | Status | Logging*..... 22
 - 4.5 VECTOR | SETUP 23
 - 4.5.1 *Vector | Setup | Channels*..... 23
 - 4.5.2 *Vector | Setup | A/B Sync* 24
 - 4.6 VECTOR | CONTROL..... 25
 - 4.7 VECTOR | ADMIN 26
 - 4.7.1 *Vector | Admin | System Settings*..... 26
 - 4.7.2 *Vector | Admin | SNMP Settings*..... 26
 - 4.7.3 *Vector | Admin | Password*..... 27
 - 4.7.4 *Vector | Admin | Software Update*..... 27
 - 4.7.5 *Vector | Admin | Misc Actions*..... 27
 - 4.8 VECTOR | HELP 28
- 5. MAIN CONTROLLER BOARD 30**
 - 5.1 INTRODUCTION 30
 - 5.1.1 *SDI Channels (1 - 2)* 30
 - 5.1.2 *Analogue Channels (3 – 6)* 30

- 5.1.3 AES (balanced via D-type connectors)..... 31
- 5.1.4 LTC (balanced via D-type connectors)..... 31
- 6. OPTION: 331-20-00 UNIVERSAL OPTION MODULE..... 32**
 - 6.1 INTRODUCTION 32
 - 6.2 SIGNAL HANDLING..... 32
 - 6.3 CONNECTORS..... 33
- 7. OPTION: 331-21-00 PASSIVE OPTION MODULE..... 34**
- 8. OPTION: 331-22-00 SD/HD/3G SDI VIDEO OPTION MODULE..... 35**
- 9. SPECIFICATION 36**
 - 9.1 GENERAL..... 36
 - 9.2 REGULATORY COMPLIANCE 36
 - 9.3 POWER..... 36
 - 9.4 NETWORK 36
 - 9.5 GPI INPUT 1: REMOTE CHANGEOVER CONTROL 37
 - 9.6 GPI INPUT 2..... 37
 - 9.7 GPI OUTPUT 1: REMOTE CHANGEOVER OUTPUT..... 37
 - 9.8 GPI OUTPUT 2: REMOTE ALARM OUTPUT..... 37
 - 9.9 SYSTEM BASE MODULE 38
 - 9.10 331-20-00 UNIVERSAL OPTION MODULE..... 41
 - 9.11 331-21-00 PASSIVE OPTION MODULE..... 42
 - 9.12 331-22-00 SD/HD/3G SDI VIDEO OPTION MODULE..... 42
 - 9.13 331-22-00 SD/HD/3G SDI VIDEO OPTION MODULE – FORMATS DETECTED AND REPORTED..... 43

1. APPLICATION

1.1 INTRODUCTION

The Trilogy 331-00-01 Mentor CX Changeover Unit is designed to complement the Trilogy RG Reference Generator. The Mentor product family is suitable for any digital or mixed-format environment where a high-quality digital SPG is required. Mentor CX provides a manual or automatic changeover between a pair of Mentor RG generators, providing the maximum possible security for on-air applications.

The following features and facilities are offered:

- Compact 1RU rack mounting package matching the Mentor RG
- Single or redundant dual power supplies
- Base Mentor CX provides:
 - 4 channels that monitor and switch Black and burst, Tri-Level-Sync, AES/DARS, word clock, 10 MHz and 27 MHz
 - 2 channels that monitor and switch SDI – SD/HD/3G signals but do not detect or report the standard
 - Monitoring and switching of balanced AES and LTC signals
- A comprehensive range of expansion modules, up to a total of 18 channels
- Both actively monitored and passively switched channels for a range of signals
- Front panel control and status indication
- Vector management, tightly integrated with Mentor RG provides full setup, monitoring and control

Also, an internal redundant power supply is available to increase MTBF or to allow AC power diversity in critical applications. A Gigabit Ethernet port is provided for the Vector browser-based management feature and to facilitate software upgrades.

This User Guide concentrates on the operational aspects of the Mentor CX and includes a full technical specification.

1.2 VECTOR - BROWSER-BASED MANAGEMENT

A browser-based configuration tool is provided, offering:

- Initial setup and management of Mentor CX
- Status overview of the entire reference chain comprising Mentor CX and the associated pair of Mentor RG generators
- Control - including choice of manual and automatic modes

Please see section 4.2 of this manual for information on getting started with Vector.

1.3 RELATED DOCUMENTS

Document	Description
33190600	Mentor CX User Guide - <i>This Document</i>
36090602	Quick Start Guide: Mentor RG plus Mentor CX
36090600	Mentor RG User Guide

1.4 AVAILABLE FEATURES AND OPTIONS

Six option card slots are available. The Mentor CX auto-detects which type of option card is fitted and presents the user with appropriate on-screen options within Vector.

Several additional hardware options are available for the Mentor CX. At the time of writing in March 2021, these are:

Part Code	Description
331-20-00	Two channel Analogue video detector/CO option module
331-21-00	Two channel Analogue and SD/HD Passive CO option module
331-22-00	Two channel SD/HD/3G video detector/CO option module
331-50-00	PSU module

1.5 TECHNICAL SUPPORT

UK & International

Please contact Trilogy at the UK headquarters.

Trilogy Communications Ltd.
2000 Beach Drive
Cambridge Research Park
Cambridge CB25 9TP
United Kingdom
Tel: +44 (0) 1264 384000
www.trilogycomms.com

Alternatively, please contact your reseller. Contact details may be found at www.trilogycomms.com.

1.6 WARRANTY



Conditions of the warranty may vary according to your terms of purchase. Please consult your sales documentation or if in doubt, contact your original supplier or Trilogy, quoting the date of purchase and unit serial number.



2. INSTALLATION

2.1 IMPORTANT SAFETY INFORMATION

Power Supply Cord(s) Used as Disconnect Means

	<p>CAUTION: THE POWER SUPPLY CORDS ARE USED AS THE MAIN DISCONNECT DEVICE. ENSURE THAT THE SOCKET-OUTLETS ARE LOCATED/INSTALLED NEAR THE EQUIPMENT AND ARE EASILY ACCESSIBLE.</p>
	<p>ATTENTION: LES CORDONS D'ALIMENTATION SONT UTILISÉS COMME DISPOSITIF DE DÉBRANCHEMENT PRINCIPAL. ASSUREZ-VOUS QUE LES PRISES DE COURANT SOIENT SITUÉES/INSTALLÉES PRÈS DE L'ÉQUIPEMENT ET QU'ELLES SOIENT FACILEMENT ACCESSIBLES.</p>

	<p>CAUTION: UNIT COVER TO BE REMOVED BY SKILLED PERSONNEL ONLY. SHOCK HAZARD EXISTS WHEN COVER IS REMOVED.</p>
	<p>ATTENTION: LE COUVERCLE DE L'UNITÉ DOIT ÊTRE RETIRÉ UNIQUEMENT PAR DU PERSONNEL QUALIFIÉ. UN RISQUE D'ÉLECTROCUTION EXISTE LORSQUE LE COUVERCLE EST RETIRÉ.</p>

	<p>CAUTION: THE UNIT MAY HAVE MORE THAN ONE POWER SUPPLY CORD. DISCONNECT ALL POWER SUPPLY CORDS BEFORE SERVICING TO AVOID ELECTRIC SHOCK.</p>
	<p>ATTENTION: L'APPAREIL PEUT AVOIR PLUS D'UN CORDON D'ALIMENTATION. DÉBRANCHEZ TOUS LES CORDONS D'ALIMENTATION AVANT L'ENTRETIEN POUR ÉVITER LES CHOCS ÉLECTRIQUES.</p>

The power supplies within the unit are a switch mode design and will automatically manage a wide input voltage range.

The equipment may be fitted with a single mains power supply, plus optionally a second unit. Each power supply has its own, dedicated, IEC mains plug on the rear of the unit. Mains cable conductors are to be three-core (two-wire with ground), wire gauge 18 AWG (cross-sectional area 0.75mm²) Cord jacket type to be SJT.

The mains socket-outlet protective earth connection must be verified by a skilled person. Incoming mains earth from the IEC connector is internally bonded to both the chassis and technical 0V to meet safety requirements and performance specifications.

The unit is provided with a single 4mm earthing stud on the rear panel. The stud allows the addition of an earth strap, if required, in rack installations.

2.2 UNPACKING

Carefully unpack the unit from its transit material and check the unit for signs of damage. Check the contents of the box against our despatch note and your original order to ensure that you have received the correct parts.

If the unit has been damaged or does not match your order, immediately contact your supplier or Trilogy at the address given at the front of this guide.

2.3 RACK MOUNTING

The 1U rack frame has integral 19" mounting ears for direct mounting in a standard 19" rack. Carefully place the unit in your rack and firmly attach it to the rack using four bolts.

IMPORTANT: The Mentor CX has air intakes on the front and fan assisted exhaust vents on the side of the unit. Ensure that these have an unobstructed airflow, otherwise, the unit may overheat. Pay particular attention to ensure that any rack wiring or cable trays do not obstruct the vent. 60mm of clear space should be allowed between the vents and any potential obstruction.

2.4 POWER SUPPLIES

The power supplies are accessible from the front of the unit, behind a retractable cover. To open the cover, use the small recesses on the left and right edges. You may find it easier to use a small screwdriver or coin in the recess but even force should be applied to both sides of the cover. The cover then hinges forwards and down, providing clear access to the power supplies.

IMPORTANT: The cover must be replaced and correctly secured during normal operation. To replace the cover, hinge it upwards and inwards then apply even force at both sides. As the cover locks into place, you will hear a firm click.

Please contact Trilogy Technical Support for any further assistance.

2.5 BATTERY

Mentor CX is fitted with an internal lithium battery.



CAUTION: RISK OF EXPLOSION IF BATTERY IS REPLACED BY AN INCORRECT TYPE. DISPOSE OF USED BATTERIES ACCORDING TO THE INSTRUCTIONS.

ATTENTION: IL Y A RISQUE D'EXPLOSION SI LA BATTERIE EST REMPLACÉE PAR UNE BATTERIE DE TYPE INCORRECT. METTRE AU REBUT LES BATTERIES USAGÉES CONFORMÉMENT AUX INSTRUCTIONS.

2.6 REAR PANEL CONNECTIONS

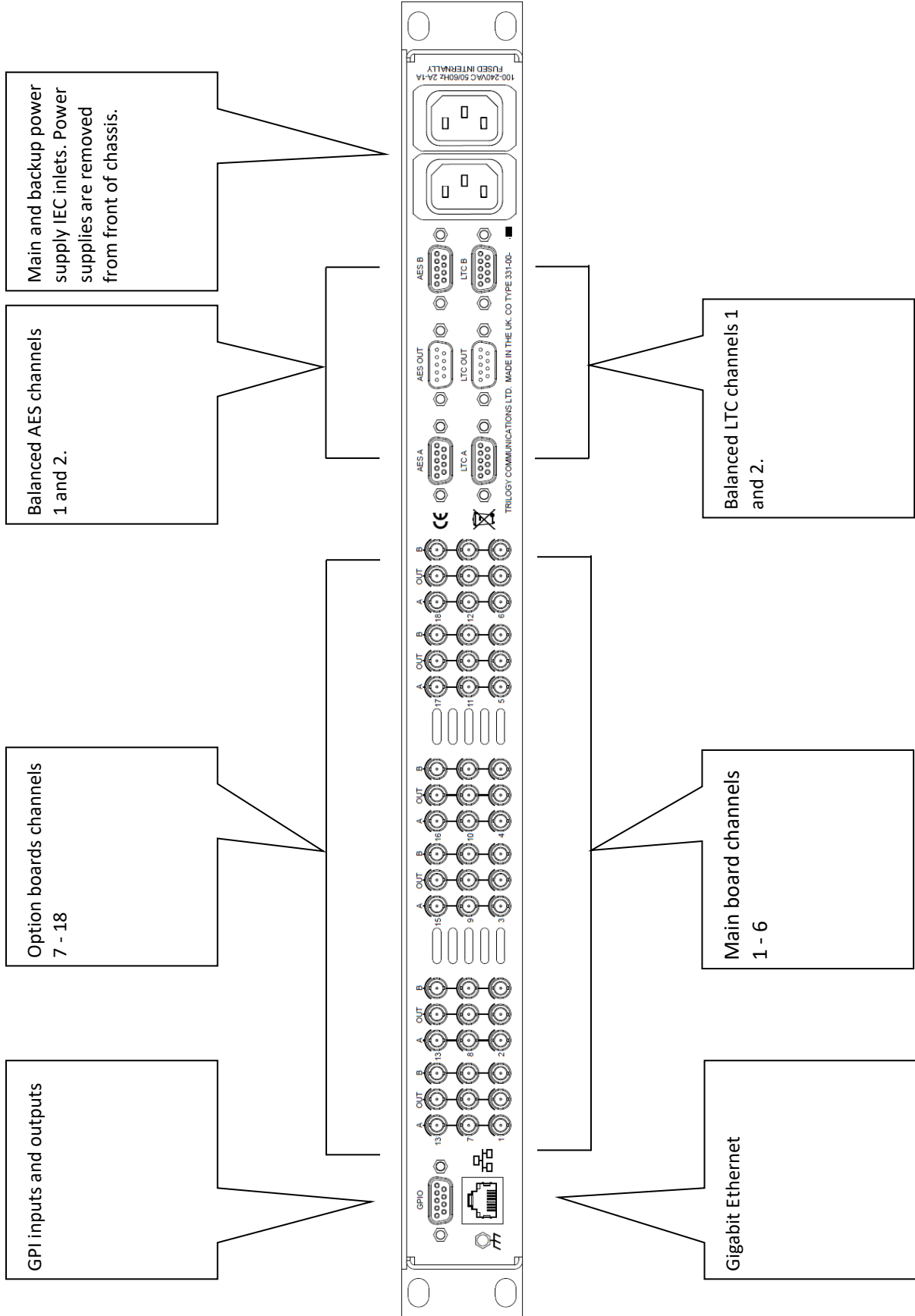

2.7 CHANNEL INPUT AND OUTPUT

Mentor CX uses the ‘Micro BNC’ connector type, which is interchangeable with the Amphenol ‘HD BNC’ range. Connector performance exceeds the requirements of SMPTE ST 2082-1 making them suitable for composite and component video, 270 Mb/s SDI, uncompressed 1080i or 1080p HD-SDI video and 4K UHD (2160P60) video up to 12GHz. The Micro BNC series is used to achieve a very high density of connections on equipment rear panels and thus requires the use of a dedicated slim-line fitting and removal tool to mate and un-mate the connector. Trilogy offers a short interconnect cable for Mentor RG outputs to Mentor CX channel inputs – please contact your usual sales channel for more information.

2.8 AES AND LTC IN FROM SPG A AND B

There are two male D9 plugs for AES inputs and two identical connectors for LTC signals. AES inputs are the upper connectors and LTC inputs are the lower connectors.

From SPG A		From SPG B
AES in from SPG A: Chassis D9 plug (male)		AES in from SPG B: Chassis D9 plug (male) - identical
Pin	Description	
1	AES 1 + (in)	
2	AES 1 - (in)	
3	n/c	
4	n/c	
5	n/c	
6	n/c	
7	AES 2 + (in)	
8	AES 2 - (in)	
9	n/c	
LTC in from SPG A: Chassis D9 plug (male)		LTC in from SPG B: Chassis D9 plug (male) - identical
Pin	Description	
1	LTC 1 + (in)	
2	LTC 1 – (in)	
3	n/c	
4	Fault Loop + (in)	
5	n/c	
6	n/c	
7	LTC 2 + (in)	
8	LTC 2 – (in)	
9	Fault Loop – (in)	

Input pins are arranged to match the corresponding output pins of the Mentor RG, allowing 1:1 cabling to be installed.

The LTC input connectors also have provision to connect the fault loop general system failure signal from each Mentor RG. This may be combined with system health data from Mentor CX to provide an overall fault loop for the associated hardware (2 x Mentor RG plus 1 x Mentor CX). See section 2.10.

2.9 AES AND LTC OUT

There are two female D9 sockets for the output of AES and LTC channels. AES out is the upper connector and LTC out is the lower connector.

AES out: Chassis D9 socket (female)	
Pin	Description
1	AES 1 + (out)
2	AES 1 - (out)
3	Shield
4	Fault Loop + (out)
5	0V GND
6	Shield
7	AES 2 + (out)
8	AES 2 - (out)
9	Fault Loop - (out)

LTC out: Chassis D9 socket (female)	
Pin	Description
1	LTC 1 + (out)
2	LTC 1 - (out)
3	Shield
4	TXD (see note 1)
5	0V GND
6	Shield
7	LTC 2 + (out)
8	LTC 2 - (out)
9	RXD (see note 1)

Note 1 – serial data is for internal debugging purposes only.

2.10 FAULT LOOP

Mentor CX has a fault loop output indicating a combined general system failure when open. The output is presented on the AES output connector as shown above. Electrically, the opto-isolated output is identical to the GPI Outputs described in section 2.11.

A fault condition on one or more of the items listed causes the Mentor CX fault loop to open.

- Mentor CX Fan 1
- Mentor CX Fan 2
- Mentor CX PSU 1
- Mentor CX PSU 2
- Fault loop primary Mentor RG (SPG A)
- Fault loop secondary Mentor RG (SPG B)

Overall fault status from each associated Mentor RG is connected to the LTC input connectors on Mentor CX to provide an overall fault loop for the entire reference system.

2.11 GPI IN AND OUT

A D9 chassis-mounted socket (female) provides GPI (general purpose interface) inputs and outputs.

GPI: Chassis D9 socket (female)	
Pin	Description
1	GND
2	GPI input 1
3	GPI input 2
4	GPI out 2 -
5	+12VDC (fused 500 mA)
6	GPI out 1 +
7	GPI out 1 -
8	GPI out 2 +
9	GND

GPI Inputs 1 and 2

GPI input 1 is used to switch between A and B inputs when the unit is configured to use GPI to control the changeover. A floating input selects “A” inputs: closure to ground selects “B” inputs.

GPI input 2 is reserved for future use.

Connecting GPI Inputs

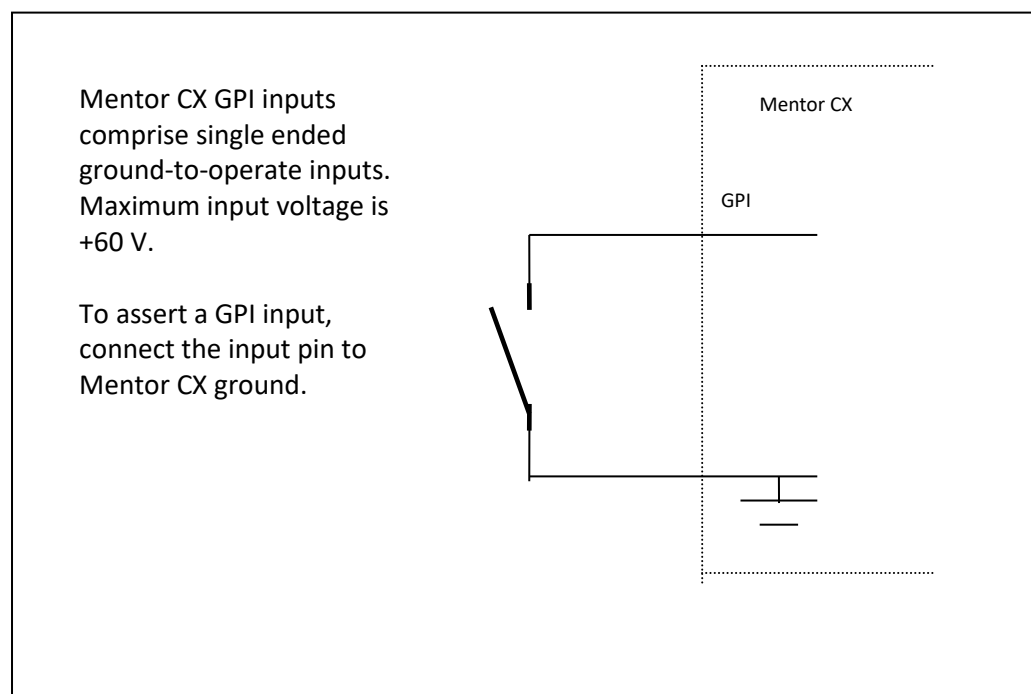

GPI Outputs 1 and 2

Output 1 indicates which set of inputs are routed to the output. When open, “A” inputs are routed, when closed “B” inputs are routed. GPI Output 1 is a latching mechanical relay and retains its setting when power is removed from the unit.

Output 2 indicates if the A&B input sets signals differ or if there is a PSU failure. When open, inputs A&B differ, or a PSU failure has been detected: when closed A&B have equivalent signals and PSUs are OK. PSU failure occurs when the PSU is detected as present, but PSU DC voltage output is not OK, or PSU fan is not OK. GPI Output 2 is an opto-isolated, floating type.

Connecting GPI Output 2

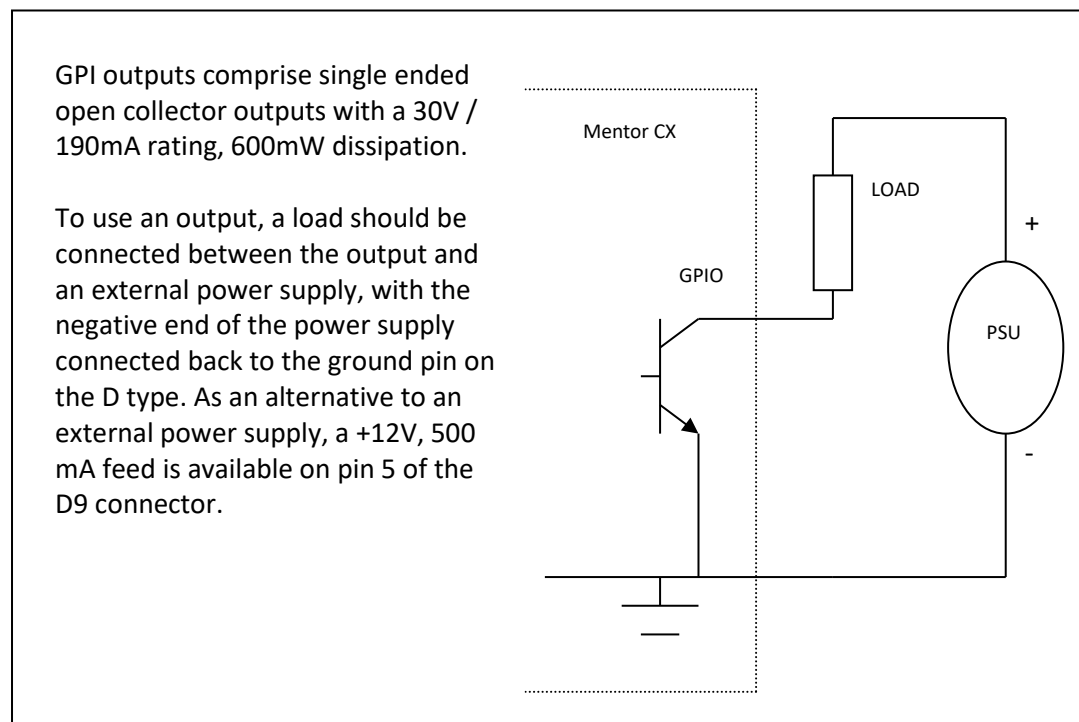

2.12 ETHERNET

The Mentor CX is equipped with a 10/100/1000 Base-T Ethernet port. This port may be configured for either dynamic (DHCP) address mode or static address mode. In most instances, we recommend the static mode. These options are in the Admin menu. The Mentor CX should be connected to the network in the same way as any other networked device (e.g. computer or laptop) using a 1:1 CAT 5 RJ45 cable (not provided).

If connected directly to a computer or laptop for initial configuration, either a crossover or 1:1 Ethernet cable may be used.

3. OPERATION

3.1 INTRODUCTION

Some basic principles are key to the operation of the Mentor CX.

1. Signal faults are classified as either “errors” or “warnings”. An error is more serious and will normally cause the Mentor CX to perform a changeover to the secondary generator. The exceptions to this rule are covered in point 3 (below). Channels may be included or excluded from the decision making using front panel controls or Vector management. A warning is less serious, does not cause a changeover but does require urgent attention.
2. Most faults, “errors” and “warnings”, result from a problem detected on one generator alone. Format difference warnings are normally the result of misconfiguration and Mentor CX cannot determine which generator is at fault. In this instance, channel input LEDs will flash yellow, alternately.
3. A changeover will only take place if the alternate generator is operating correctly. This means that the alternate must not show any errors, nor must there be any format difference warnings on monitored channels.
4. The logic underpinning automatic changeover is fundamentally “one time only”. So, if an error occurs, Mentor CX will switch from the primary to the secondary generator. A further switch back to primary will not occur without manual intervention. This is to eliminate the possibility of repeated back and fore switching which would be very disruptive. The “one time only” approach means that the reserve generator will now remain in service until the problem is resolved and the Mentor CX is manually reset.

A limited amount of information and key aspects of control are presented at the front panel and these are described first. More complete operation and system setup are provided by Vector management and this is described in section 4 - Using Vector | Browser-Based Management.

3.2 FRONT PANEL

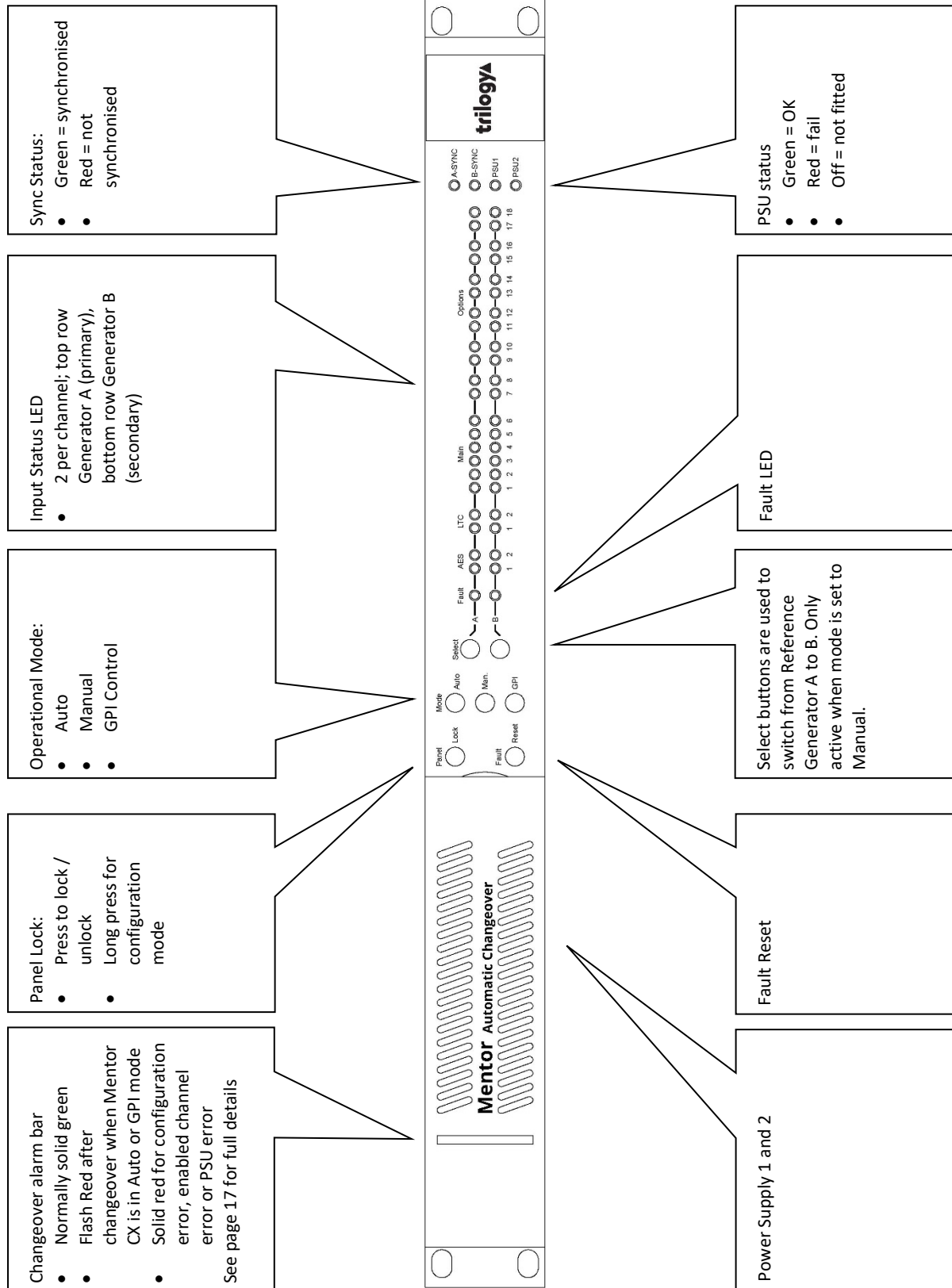

3.3 CONTROLS

Panel controls are only active when the panel is unlocked. *Control actions related to configuration mode are shown in italics.*

	Button	Indicator
Panel Lock	<p>Momentary press alternates between locked and unlocked. When unlocked, if there is no user input for 30 seconds, the panel will automatically lock.</p> <p><i>5-second press to enter configuration mode – momentary press to exit configuration mode. When in configuration mode, if no action has been performed on the switches used in configuration mode (i.e. buttons A and B) then after a 15-second timeout, the panel will go back to normal mode.</i></p>	<p>On = locked Off = unlocked (normal mode)</p> <p><i>Flashing = configuration mode</i></p>
Operational Mode	<p>Three interlocked buttons:</p> <ul style="list-style-type: none"> • Automatic • Manual • GPI Input control 	On = mode currently selected
Select	<p>Two interlocked buttons, only active in manual operation mode:</p> <ul style="list-style-type: none"> • Select Reference Generator A • Select Reference Generator B <p><i>Button A – cycle through channels</i> <i>Button B – enable/disable selected channel</i></p>	On = currently selected – displayed in all operational modes
Fault Reset	<p>Momentary press to reset changeover alarm Press and hold on power-up to set the IP address to factory default (192.168.1.252).</p>	

3.4 INDICATORS

PSU1 and PSU2

- **Green** = PSU module in normal operational mode, AC input is applied, the DC voltage rail is within specification and the fan is OK
- **Red** = There is an error with a PSU module (AC input is not applied; DC voltage is out of range or fan fail.)
- **Off** = PSU module not fitted.

Reference Generator Sync Status, A (primary) and B (secondary)

- **Green** = Generator synchronised
- **Red** = Generator not synchronised.

Input status

There are individual LED indicators for each input, 2 per channel. They also have a secondary purpose when Mentor CX is in *configuration mode*.

Normal mode	<i>Configuration Mode</i>
Green = input OK Flashing Green = input "Warning" – see note below Red = input "ERROR" – see note below Both flashing yellow alternately = inputs A and B are different formats – see note below Flashing Red = invalid state Off = channel not enabled	<i>Green = channel is enabled</i> <i>Red = channel is disabled.</i>

Note: For details of specific warning and error indications for each channel input, please refer to the detailed specifications commencing in section 9.9 on page 38 of this manual.

Changeover Alarm Bar

This translucent LED bar is located on the left side of the front panel.

- **Green** for normal operation
- **Flashing Red** to indicate a changeover has occurred when the unit is in auto or GPI control mode
- **Flashing Green** to indicate a firmware update is in progress
- **Flashing Green** at a **rapid** rate to indicate the system is in boot recovery mode
- **Red** when there is a configuration error i.e. no channels are enabled for monitoring. It is also red if an enabled channel is in error or if there is a PSU error.

4. USING VECTOR | BROWSER-BASED MANAGEMENT

4.1 INTRODUCTION

Vector, a browser-based configuration tool provides:

- Greatly simplified initial setup
- Online editing of Mentor CX configurations
- Visibility of your entire Trilogy Mentor reference system
- Partial or incremental updates without causing disruption (where possible)
- The ability to copy, backup and restore configuration data

4.2 GETTING STARTED

To start using Vector, follow these simple steps to set the Mentor CX IP address:

- Power up the Mentor CX while holding down the “Fault Reset” button on the front panel. The IP address will return to the factory default of 192.168.1.252.
- Connect the Ethernet port on the Mentor CX to a laptop, using a standard RJ-45 cable (not supplied). Give the laptop a temporary IP address within the same subnet (e.g.192.168.1.20).
- Open your web browser and Navigate to the address <http://192.168.1.252>.
- Select Admin from the top menu and at the log-in screen, enter the default username **admin** and password **trilogy**. The System Settings page will then be displayed.

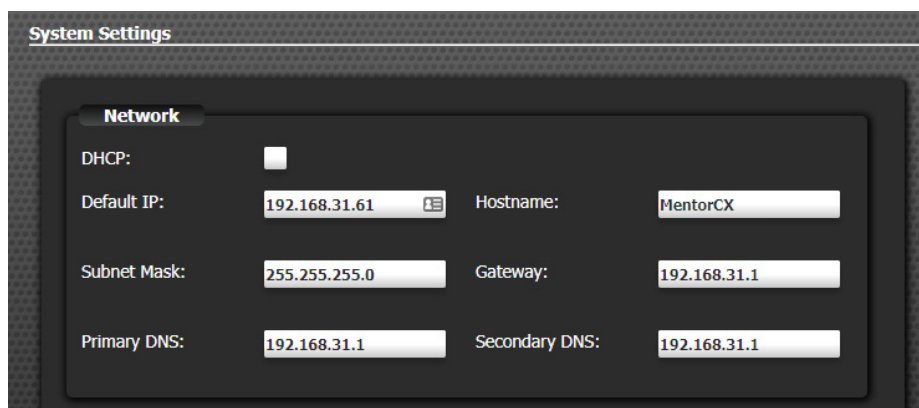

- As a minimum, enter values for Default IP and Subnet Mask which are appropriate for your in-house network. A Gateway address will be required if you intend to access the Mentor CX across a wider network. Use of DHCP is not normally advised for technical equipment.
- A change of Default IP address will mean that you lose contact with the laptop. Once the change has taken place you can disconnect the laptop and connect Mentor CX to your LAN.
- Log in again from a PC connected to your LAN.

4.3 TOP LEVEL MENU

From the web browser, the top-level menu is always displayed within the blue horizontal bar. The selected item is indicated by a “pressed button” image.

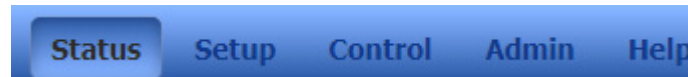

The second navigation level is a vertical side-bar and the selected item, in this case, “Overview”, is repeated within the panel immediately to the right.

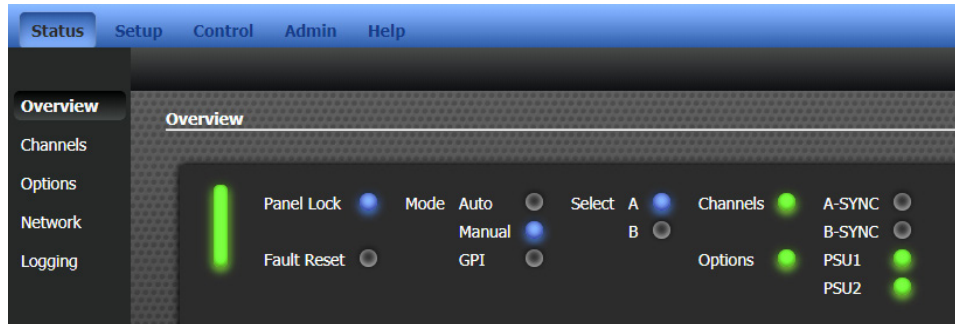

Here is the key:

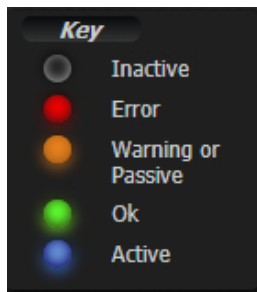

Note:

1. Signal status or health is indicated by the “traffic signal” colours.
2. A selected mode or active state is indicated in blue.
3. An inactive state is shown by a clear indicator.

The examples below show the optional power supply, PSU2.

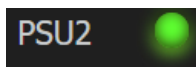

PSU2 is present and operating correctly

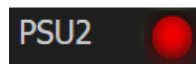

PSU2 is fitted but has failed

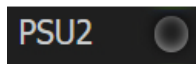

PSU2 is not fitted

The content and features of each menu branch are explained later in this section of the manual.

4.4 VECTOR | STATUS

The status menu has five branches, as shown in the first image below.

4.4.1 Vector | Status | Overview



This page provides an overview of the entire Mentor reference system, i.e. the Mentor CX and the two associated Mentor RG. The IP addresses of the linked Mentor RG should be entered on the Admin | System Settings page – see section 4.7.

4.4.2 Vector | Status | Channels

Channel status is provided on three pages.

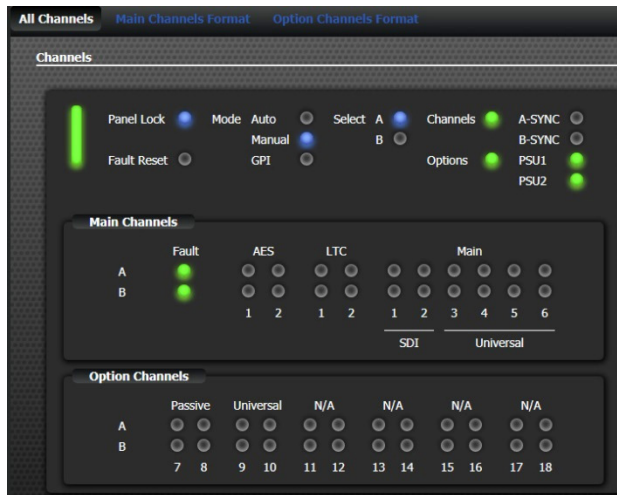

All Channels



Main Channel Formats

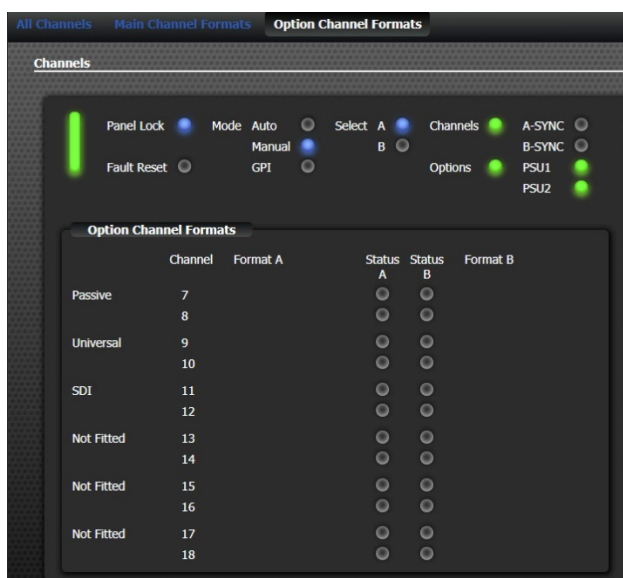

Option Channel Formats

4.4.3 Vector | Status | Options

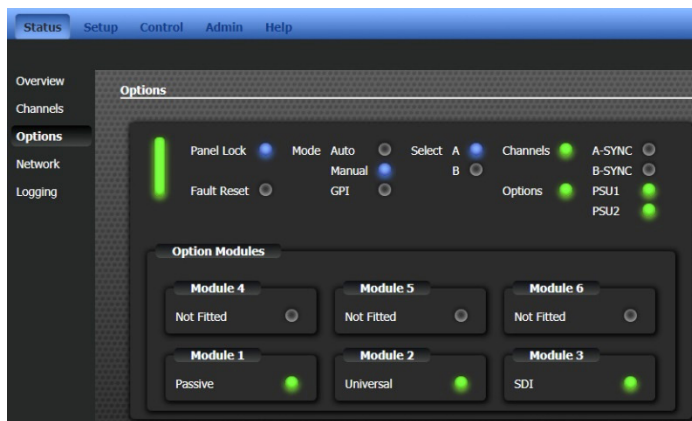

Installed Option Modules are denoted by a green indicator and appropriate text to identify module type.

4.4.4 Vector | Status | Network



This page provides read-only information for the current network settings. Any changes can be made after logging in to the Admin page – see section 4.7.

Links to the associated Mentor RG Reference Generators will open in new browser tabs.

4.4.5 Vector | Status | Logging

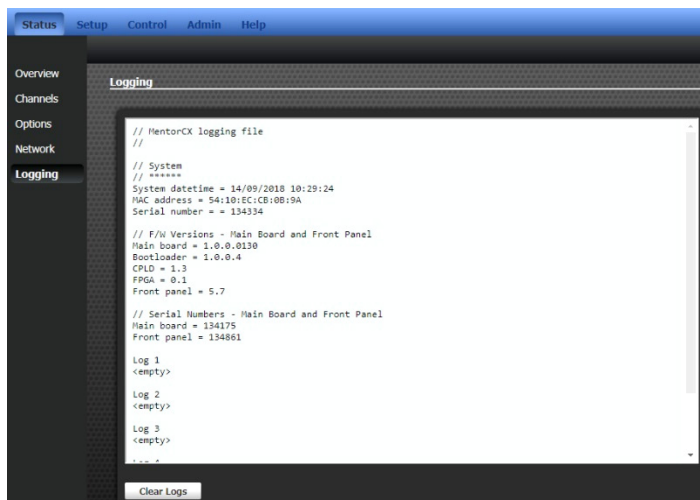

4.5 VECTOR | SETUP

4.5.1 Vector | Setup | Channels

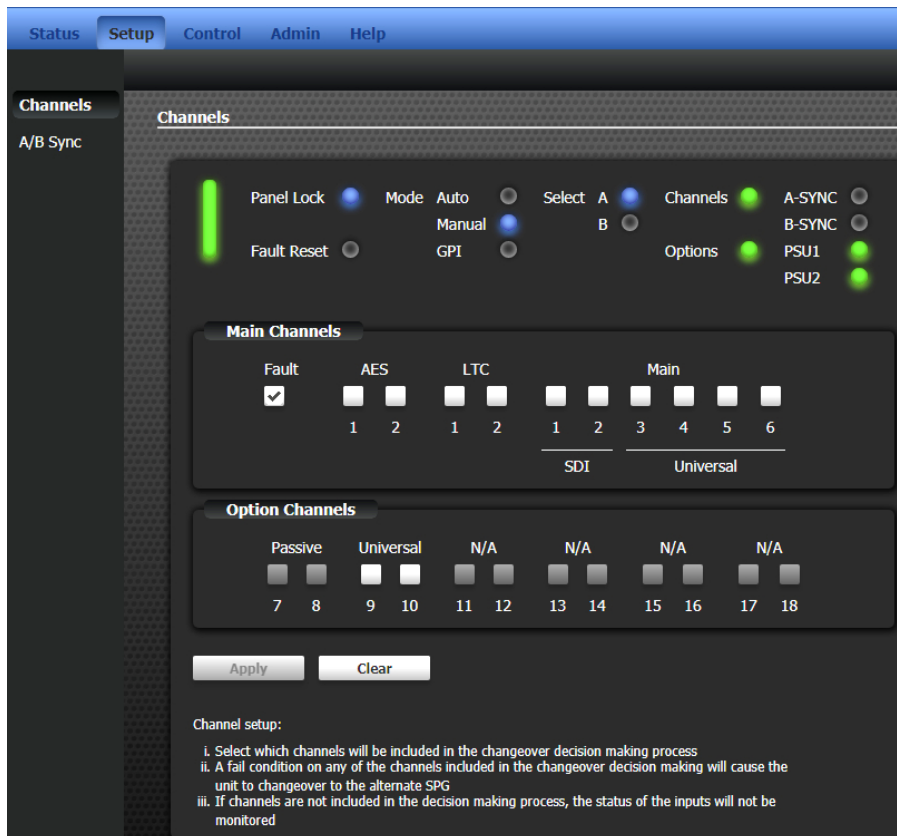

This screen allows channels to be included in or excluded from the changeover decision making process.

Channel setup:

- Select which channels will be included in the changeover decision-making process
- An error condition on any of the channels included in the changeover decision making will cause the unit to change over to the alternate SPG
- If channels are not included in the decision-making process, the status of the inputs will not be monitored

4.5.2 Vector | Setup | A/B Sync

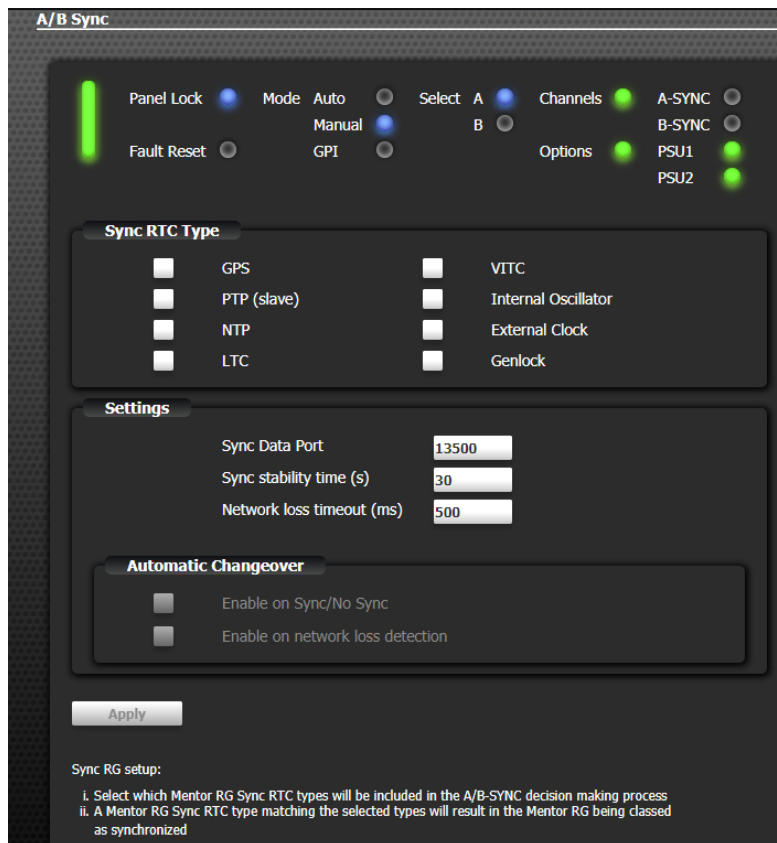

The Mentor CX monitors the status of linked Mentor RGs to see if they are locked using one of the approved synchronisation method(s) e.g. GPS, PTP, NTP etc. The list of approved synchronisation methods is configured on this screen. The status of each Mentor RG is monitored via the network and reported accordingly.

The following will cause a **sync fail** condition:

- The Mentor RG reports a synchronisation method not approved in the configured list.

The following causes a **sync warning** :

- Both Mentor RG report a synchronisation method from the approved configured list, but the synchronisation methods differ.

The Mentor RG synchronisation methods are:

- GPS
- PTP (slave)
- NTP
- LTC
- VITC
- Internal oscillator
- External clock; and
- Genlock

The settings section is there to ensure we don't get a period of changeover when there are network stability issues.

4.6 VECTOR | CONTROL

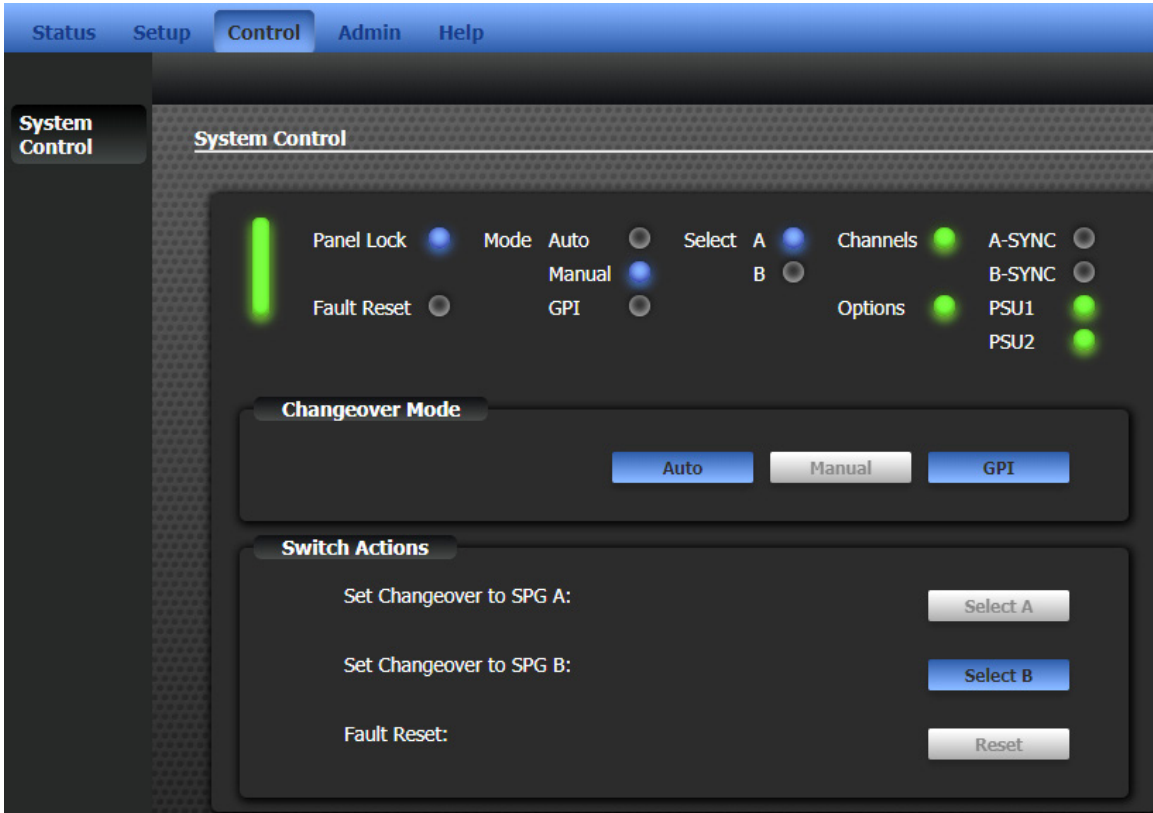

The control screen provides all elements of control.

- Changeover Mode:
 - Auto = controlled by detecting errors on incoming signals from connected Mentor RG
 - Manual = controlled on-screen or from the front panel
 - GPI = external control connected to GPI input. See section 2.11.
 - Switch Actions:
 - Select A / B causes an immediate changeover when in manual mode (above)
- Fault Reset clears any existing fault alarms

4.7 VECTOR | ADMIN

The Admin menu comprises five branches, as shown in the first image below.

4.7.1 Vector | Admin | System Settings

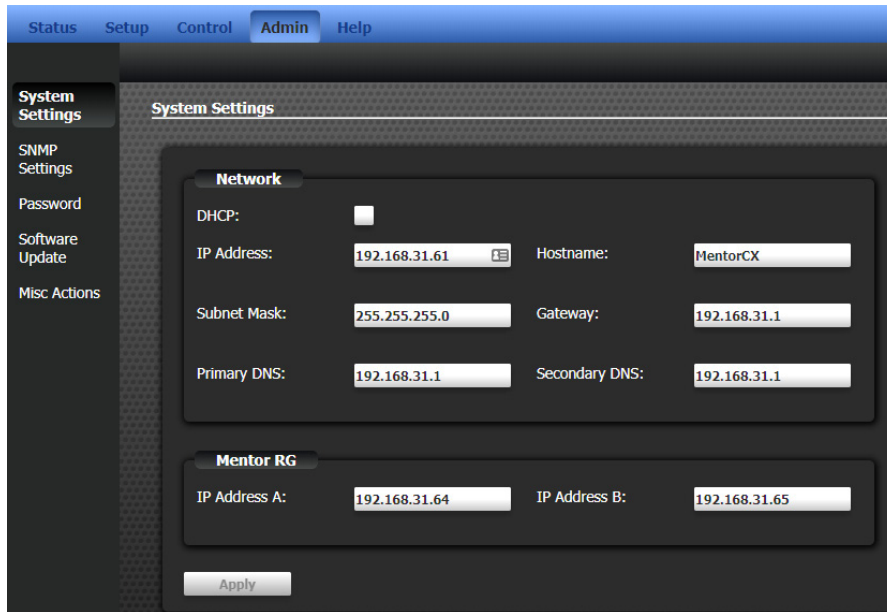

The Admin | System Settings page allows the Mentor CX IP address to be set correctly, to match local network requirements. Although DHCP is supported, it is not normally appropriate in a technical environment such as a broadcast studio.

The minimum values required for correct operation are Default IP and Subnet Mask. These values alone will allow the Mentor CX to be accessed by an admin PC located on the same subnet. If you plan to access the Mentor CX from a different subnet then a Gateway address must be entered. The factory default IP address is 192.168.1.252 with subnet mask 255.255.255.0.

Each Mentor CX Changeover is normally connected to a pair of Mentor RG Reference Generators. If the IP addresses of these linked reference generators are entered, the main status page will display an overview of the status of the entire system. In-depth status reporting and setup of the Mentor RG is available by browsing directly to each unit.

4.7.2 Vector | Admin | SNMP Settings

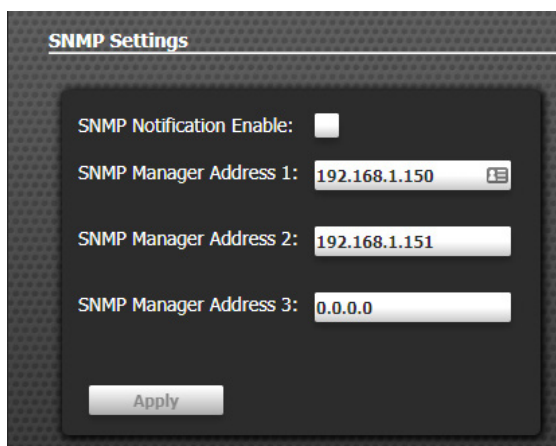

Check the box to enable SNMP notifications. A maximum of three SNMP managers may be added.

4.7.3 Vector | Admin | Password

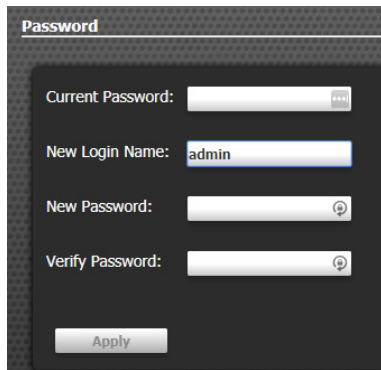

Factory defaults are:
Login name – **admin**
Password - **trilogy**

4.7.4 Vector | Admin | Software Update

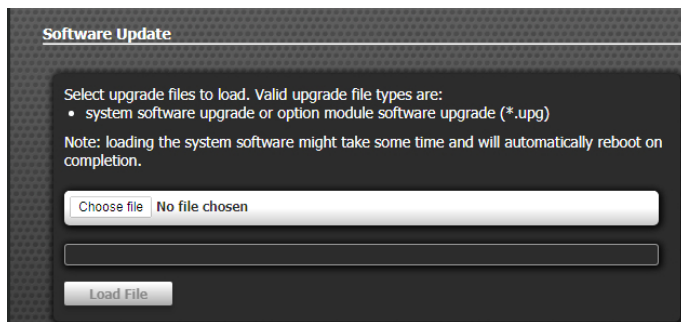

Update files for Mentor CX and option boards will be supplied by Trilogy Technical Support. Any software update may be disruptive and should be carefully scheduled. Please contact Trilogy for further details.

4.7.5 Vector | Admin | Misc Actions

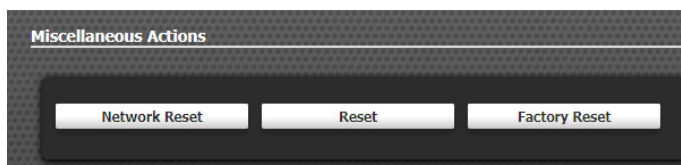

Three miscellaneous actions are presented. Network reset occurs as soon as the button is clicked. The interface is reset but settings are retained.

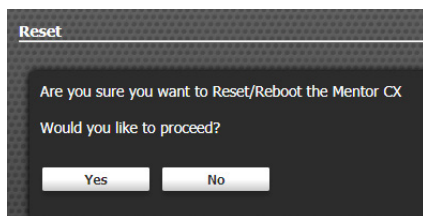

This warning prompt is shown for the “Reset” action.

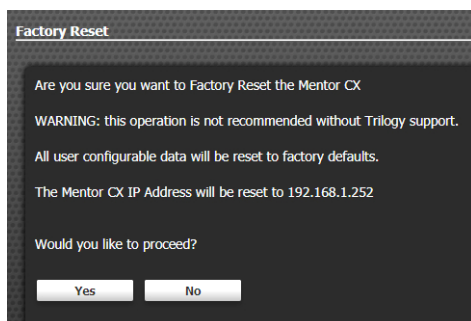

This warning prompt is shown for the “Factory Reset” action. Please read the note carefully before proceeding.

4.8 VECTOR | HELP

There are three items on the Help menu, as shown below. The info page has two tabs.



The info page provides a summary of currently installed software for the Mentor CX and any fitted option boards. There are two tabs, **General** and **Technical Support**. The General tab presents an overview, in a user-friendly format.

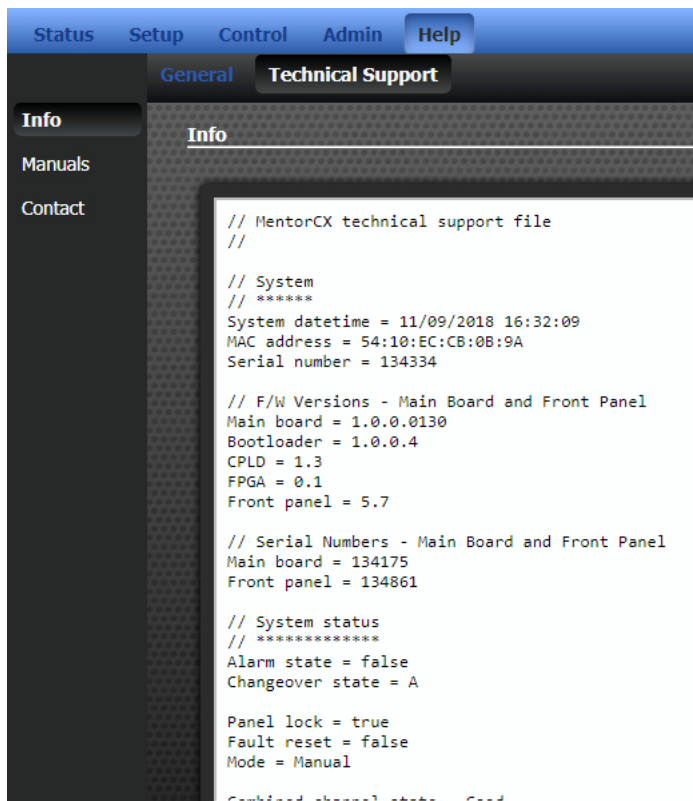

If you contact Trilogy Technical Support, our engineers will request information from this screen to assist in answering your question.

To make a copy of the complete information:

- Place your cursor anywhere within the text area
- Press <ctrl + A> to select all the text
- Press <ctrl + C> to copy
- Create a new plain text (.txt) file on your desktop and open the file
- Place your cursor in the new text file and press <ctrl + V> to paste
- Save the text file with an appropriate filename

Manuals

[Quick Start Guide](#)



[User Guide](#)



PDF versions of the Mentor CX User Guides can be downloaded from the support website by clicking the short links on this page. QR codes provide an easy way for smartphone users to download documents.

Contact Information



trilogycomms.com
twitter.com/trilogycomms

Trilogy Communications Ltd
26 Focus Way, Andover, Hampshire
SP10 5NY, United Kingdom

Trilogy USA Inc
1301 Marina Village Parkway
Suite 105
Alameda, CA 94501, USA

Telephone. +44 (0) 1264 384000 Telephone. +1 847-461-1480
Email. support@trilogycomms.com Toll Free. +1 855-237-4624

5. MAIN CONTROLLER BOARD

5.1 INTRODUCTION

In addition to providing overall control of the Mentor CX, the main controller board carries the following channels which constitute the “base” unit:

- 2 x SDI - channels 1 - 2
- 4 x Analogue - channels 3 - 6
- 2 x AES (balanced via D-type connectors)
- 2 x LTC (balanced via D-type connectors)

The features of each channel type are described below.

5.1.1 SDI Channels (1 - 2)

The inputs monitor SDI – SD/HD/3G signals, but do not detect or report the format/standard.

The following error causes an error condition:

- Signal level approx. <500 mV.

5.1.2 Analogue Channels (3 – 6)

Four analogue channels can monitor and switch the following signal types:

- Black and burst (BB)
- Tri-Level-Sync (TLS)
- AES/DARS (unbalanced via BNC)
- Word clock, 10 MHz, 27 MHz

Black and burst (BB)

Mentor CX monitors PAL and NTSC BB and reports the detected standard.

- Signal amplitude <180 mV causes an error condition
- Signal amplitude <210 mV (double terminated) or >500 mV (un-terminated) causes a warning condition.

Tri-Level Sync (TLS)

The following 22 standards are monitored, detected and reported (see exceptions listed).

Description	Description	(reports as)
1920x1080/60/p	1920x1080/30/sF	1920x1080/60/i
1920x1080/59.94/p	1920x1080/29.97/sF	1920x1080/59.94/i
1920x1080/50/p	1920x1080/25/sF	1920x1080/50/i
1920x1080/60/i	1280x720/60/p	
1920x1080/59.94/i	1280x720/59.94/p	
1920x1080/50/i	1280x720/50/p	
1920x1080/30/p	1280x720/30/p	
1920x1080/29.97/p	1280x720/29.97/p	
1920x1080/25/p	1280x720/25/p	
1920x1080/24/p	1280x720/24/p	
1920x1080/23.98/p	1280x720/23.98/p	

- Signal amplitude <180 mV causes an error condition
- Signal amplitude <210 mV (double terminated) or >500 mV (un-terminated) causes a warning condition but does not cause changeover to occur.

AES/DARS (unbalanced via BNC)

AES signals from the Mentor RG can be transmitted as unbalanced via a 75Ω BNC output, or balanced via a D-type connector. See section 5.1.3 for information about a balanced connection.

Mentor CX supports AES with 32, 44.1, 48 and 96 kHz sampling frequencies.

The following faults cause an error condition:

- Peak-to-peak signal level <320 mV
- Incorrect AES preamble.

Word Clock, 10 MHz and 27 MHz

The word clock, 10 MHz and 27 MHz signals from the Mentor RG are transmitted as 75 Ω BNC outputs. The maximum amplitude the unit has to cope with is 10V peak to peak. The signal type is automatically detected and reported.

The following fault causes an error condition:

- Peak-to-peak signal level <320 mV.

5.1.3 AES (balanced via D-type connectors)

AES signals from the Mentor RG can be transmitted as unbalanced via a 75Ω BNC output, or balanced via a D-type connector. See section 5.1.2 for information about an unbalanced connection.

Mentor CX supports AES with 32, 44.1, 48 and 96 kHz sampling frequencies.

The following faults cause an error condition:

- Peak-to-peak signal level <200 mV
- Incorrect AES preamble.

5.1.4 LTC (balanced via D-type connectors)

LTC from the Mentor RG is transmitted as a balanced signal via a D-type connector.

The following faults cause an error condition:

- Peak-to-peak signal level <500 mV
- Incorrect LTC sync word.

The following fault causes a warning condition but does not cause changeover to occur:

- Discontinuous timecode.

6. OPTION: 331-20-00 UNIVERSAL OPTION MODULE

6.1 INTRODUCTION

This optional module can handle the following signals:

- Black and burst (BB)
- Tri-Level-Sync (TLS)
- AES/DARS (unbalanced via BNC)
- Word clock, 10 MHz, 27 MHz

Each option module provides two changeover “channels”, where a channel comprises two inputs (A and B) plus one switched output. The module may be fitted in any of the six available option slots.

6.2 SIGNAL HANDLING

Black and burst (BB)

Mentor CX monitors PAL and NTSC BB and reports the detected standard.

- Signal amplitude <180 mV causes an error condition
- Signal amplitude <210 mV (double terminated) or >500 mV (un-terminated) causes a warning condition.

Tri-Level Sync (TLS)

The following 22 standards are monitored, detected and reported (see exceptions listed).

Description	Description	(reports as)
1920x1080/60/p	1920x1080/30/sF	1920x1080/60/i
1920x1080/59.94/p	1920x1080/29.97/sF	1920x1080/59.94/i
1920x1080/50/p	1920x1080/25/sF	1920x1080/50/i
1920x1080/60/i	1280x720/60/p	
1920x1080/59.94/i	1280x720/59.94/p	
1920x1080/50/i	1280x720/50/p	
1920x1080/30/p	1280x720/30/p	
1920x1080/29.97/p	1280x720/29.97/p	
1920x1080/25/p	1280x720/25/p	
1920x1080/24/p	1280x720/24/p	
1920x1080/23.98/p	1280x720/23.98/p	

- Signal amplitude <180 mV causes an error condition
- Signal amplitude <210 mV (double terminated) or >500 mV (un-terminated) causes a warning condition but does not cause changeover to occur.

AES/DARS (unbalanced via BNC)

AES signals from the Mentor RG can be transmitted as unbalanced via a 75Ω BNC output, or balanced via a D-type connector. See section 5.1.3 for information about a balanced connection. Mentor CX supports AES with 32, 44.1, 48 and 96 kHz sampling frequencies.

The following faults cause an error condition:

- Peak-to-peak signal level <320 mV
- Incorrect AES preamble.

Word Clock, 10 MHz and 27 MHz

The word clock, 10 MHz and 27 MHz signals from the Mentor RG are transmitted as 75 Ω BNC outputs. The maximum amplitude the unit has to cope with is 10V peak to peak. The signal type is automatically detected and reported.

The following fault causes an error condition:

- Peak-to-peak signal level <320 mV.

6.3 CONNECTORS

Each option module provides two changeover “channels”, where a channel comprises two inputs (A and B) plus one switched output. The module may be fitted in any of the six available option slots. Mentor CX uses the high density ‘Micro BNC’ connector type, which is interchangeable with the Amphenol ‘HD BNC’ range. The image below shows the option module fitted in the last available option slot, numbered 17/18.

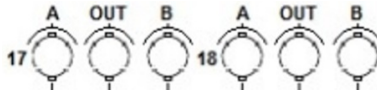

7. OPTION: 331-21-00 PASSIVE OPTION MODULE

This optional module can change over the following signals:

- Black and burst (BB)
- Tri-Level-Sync (TLS)
- AES/DARS (unbalanced via BNC)
- Word clock, 10 MHz, 27 MHz
- SD/HD/3G SDI video

There is no monitoring, detection or reporting capability.

Each option module provides two changeover “channels”, where a channel comprises two inputs (A and B) plus one switched output. The module may be fitted in any of the six available option slots. Mentor CX uses the high density ‘Micro BNC’ connector type, which is interchangeable with the Amphenol ‘HD BNC’ range. The image below shows the option module fitted in the last available option slot, numbered 17/18.

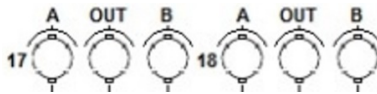

8. OPTION: 331-22-00 SD/HD/3G SDI VIDEO OPTION MODULE

This optional module is capable of monitoring and changing over the following signals:

- SD/HD/3G SDI video

The signal format is automatically detected and reported. Formats detected are listed in the Specifications – see section 9.13.

Each option module provides two changeover “channels”, where a channel comprises two inputs (A and B) plus one switched output. The module may be fitted in any of the six available option slots. Mentor CX uses the high density ‘Micro BNC’ connector type, which is interchangeable with the Amphenol ‘HD BNC’ range. The image below shows the option module fitted in the last available option slot, numbered 17/18.

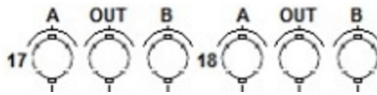

9. SPECIFICATION

9.1 GENERAL

Width	482 mm (including rack ears) 19" rack mounting
Height	44 mm (1U)
Depth	433 mm (excluding connectors)
Weight	4kg with no option boards 5kg max. with all option boards
Operating temperature range	0°C to 50°C
Storage temperature range	-20°C to 60°C
Operating humidity	20% - 90% (non-condensing when operating at 40°C)

9.2 REGULATORY COMPLIANCE

Emissions	EN 55032:2015 FCC CFR 47 Part 15.107 & 15.109 and ICES-003 Issue 6 EN 61000-3-2:2014, EN 61000-3-3:2013
Immunity	EN 55103-2:2009
Safety	IEC 62368-1:2018

NOTE: Immunity is specified to criterion B - the outputs may suffer some degradation during the disturbance but will recover on removal of the disturbance source and continue to operate as intended.

9.3 POWER

Power Supplies	The Mentor CX can accommodate two PSU modules providing the option to support PSU redundancy. PSU modules are load sharing and hot-swappable.
Mains input x 2	100-240VAC, 50/60Hz, auto select
Power consumption	80 W maximum (depending on the number of option boards fitted)
Internal Fuse	3.15A

9.4 NETWORK

Gigabit Ethernet	RJ-45 interface configured for static IP address.
------------------	---

9.5 GPI INPUT 1: REMOTE CHANGEOVER CONTROL

Type	Current sinking type (also referred to as ground closure type).
Purpose	Controls output selection when the system changeover mode is configured for GPI.
Input activation	Selects the secondary channel set ≤ 1.0 V (wrt interface system 0V) ≤ 6 k Ω (contact to interface system ground)
Input deactivation	Selects primary channel set ≥ 2.0 V (wrt interface system 0V)
Maximum input voltage	+ 60 V

9.6 GPI INPUT 2

Type	Current sinking type (also referred to as ground closure type).
Purpose	TBD
Input activation	≤ 1.0 V (wrt interface system 0V) ≤ 6 k Ω (contact to interface system ground)
Input deactivation	≥ 2.0 V (wrt interface system 0V)
Maximum input voltage	+ 60 V

9.7 GPI OUTPUT 1: REMOTE CHANGEOVER OUTPUT

Type	Relay contact -Latched
Purpose	Indicates current output channel set (Retains indication when the system loses power).
Sense	Open = Primary channel set selected Closed = Secondary channel set selected
Max. load voltage	+30 VDC
Max. load current	1 A

9.8 GPI OUTPUT 2: REMOTE ALARM OUTPUT

Type	Opto-isolated floating type
Purpose	Indicates if primary and secondary channel set signals are different format or if there is PSU module failure. Note: PSU module present but not powered or PSU module fan failure constitutes PSU module failure.
Sense	Floating = Alarm Closed = OK
Max. load voltage	+60 VDC
Max. load current	250 mA
Max. power dissipation	450 mW

9.9 SYSTEM BASE MODULE

Channel Set Type	Balanced AES/LTC
Number of Channel Sets	2 AES pairs/2 LTC pairs
Changeover Type	Latching relay Retains selected channel set on power fail Unselected channel terminated into 100 Ω.
Switching Time	Typically, <1.5 ms (max <3.0 ms)
Crosstalk	[Unselected input to output, channel to channel] <-50dB 100kHz to 12MHz.
Fault detection condition	<p>Signal Type: LTC</p> <p>Error condition</p> <ul style="list-style-type: none"> • Signal low-level threshold <500 mVpp • Incorrect LTC sync word <p>Warning condition</p> <ul style="list-style-type: none"> • Discontinuous timecode. • Detected format difference (see Note 1 below) <hr/> <p>Signal Type: AES</p> <p>Error condition</p> <ul style="list-style-type: none"> • Signal low-level threshold <200 mVpp • Incorrect AES preamble <p>Warning condition</p> <ul style="list-style-type: none"> • Detected format difference (see Note 1 below) <p>Supports AES with 32, 44.1, 48 and 96 kHz sampling frequencies.</p>

NOTE 1: Detection between different signal types – for example, between AES and LTC.

SYSTEM BASE MODULE (CONT'D)

Channel Set Type	NTSC, PAL, Tri-level Sync (TLS), AES/DARS, word clock, clock 10 MHz, clock 27 MHz
Number of Channel sets	4
Changeover Type	Latching relay Retains selected channel set on power fail. Unselected channel terminated into 75 Ω.
Switching Time	Typically, <1 ms (max <3 ms)
Return Loss	Better than -40dB to 6 MHz
Crosstalk	[Unselected input to output, channel to channel] <-60dB, 100 kHz to 6 MHz <-50dB, 6 MHz to 50 MHz
Fault detection condition	<p>Signal Type: NTSC, PAL, TLS</p> <p>Error condition</p> <ul style="list-style-type: none"> • Signal low-level threshold <180 mV <p>Warning condition</p> <ul style="list-style-type: none"> • Signal low-level threshold <210 mV • Signal high-level threshold >500 mV • Detected format difference <p>Format detection as detailed in section 5.1.2</p>
	<p>Signal Type: AES</p> <p>Error condition</p> <ul style="list-style-type: none"> • Signal low-level threshold <320 mVpp • Incorrect AES preamble <p>Warning condition</p> <ul style="list-style-type: none"> • Detected format difference <p>Supports AES with 32, 44.1, 48 and 96 kHz sampling frequencies</p>

SYSTEM BASE MODULE (CONT'D)

Channel Set Type	SD-SDI, HD-SDI, 3G-SDI
Number of channel sets	2
Changeover Type	HF 3 GHz latching relay Retains selected channel set on power fail
Switching Time	Typically <1.5 ms (max <10 ms)
Return Loss	<-15dB 5 MHz to 1.5 GHz <-10dB 1.5 GHz to 3 GHz
Crosstalk	[Unselected input to output, channel to channel] <-55dB, 100 kHz to 900 MHz <-30dB, 900 MHz to 3 GHz
Timing Jitter	[100% Colour bars] < 0.20 U _{Ipp} [>10 Hz] - SD-SDI < 0.30 U _{Ipp} [10 Hz-20 kHz] - HD-SDI < 0.60 U _{Ipp} [10 Hz-20 kHz] - 3G-SDI
Alignment Jitter	[100% Colour bars] < 0.20 U _{Ipp} [1kHz -27 MHz] < 0.20 U _{Ipp} [0.1 -148.5 MHz] < 0.30 U _{Ipp} [0.1 – 297 MHz]

9.10 331-20-00 UNIVERSAL OPTION MODULE

Channel Set Type	NTSC, PAL, Tri-level, AES/DARS, word clock, clock 10 MHz, clock 27 MHz
Number of channel sets	2
Changeover Type	Latching relay Retains selected channel set on power fail. Unselected channel terminated into 75 Ω.
Switching Time	Typically, <1 ms (max <3 ms)
Return Loss	Better than -40dB to 6 MHz
Crosstalk	[Unselected input to output, channel to channel] <-60dB, 100 kHz to 6 MHz <-50dB, 6 MHz to 50 MHz
Fault detection condition	<p>Signal Type: NTSC, PAL, Tri-level Error condition</p> <ul style="list-style-type: none"> • Signal low-level threshold <180 mV <p>Warning condition</p> <ul style="list-style-type: none"> • Signal low-level threshold <210 mV • Signal high-level threshold >50 0mV • Detected format difference <p>Format detection as detailed in section 6.2</p> <hr/> <p>Signal Type: AES Error condition</p> <ul style="list-style-type: none"> • Signal low-level threshold <320 mVpp • Incorrect AES preamble <p>Warning condition</p> <ul style="list-style-type: none"> • Detected format difference <p>Supports AES with 32, 44.1, 48 and 96 kHz sampling frequencies.</p> <hr/> <p>Signal Type: Word clock, 10 MHz clock, 27 MHz clock Error condition</p> <ul style="list-style-type: none"> • Signal low-level threshold <320 mVpp <p>Warning condition</p> <ul style="list-style-type: none"> • Detected format difference <p>Note: for 27 MHz, clock threshold accuracy margin increased to 25%.</p> <p>Supports 10 MHz, 27 MHz and Word clock at the detected AES sample rate.</p>

9.11 331-21-00 PASSIVE OPTION MODULE

Channel Set Type	Single-ended video up to 3 GHz
Number of channel sets	2
Changeover Type	HF 3 GHz latching relay Retains selected channel set on power fail
Switching Time	Typically <1.5 ms (max <10 ms)
Return Loss	<-40dB up to 5 MHz <-15dB 5 MHz to 1.5G Hz <-10dB 1.5GHz to 3GHz
Crosstalk	[Unselected input to output, channel to channel] <-55dB, 100 kHz to 900 MHz <-30dB, 900 MHz to 3 GHz
Timing Jitter	[100% Colour bars] < 0.20 UIpp [>10Hz] - SD-SDI < 0.30 UIpp [10Hz-20kHz] - HD-SDI < 0.60 UIpp [10Hz-20kHz] - 3G-SDI
Alignment Jitter	[100% Colour bars] < 0.20 UIpp [1 kHz -27 MHz] < 0.20 UIpp [0.1 -148.5 MHz] < 0.30 UIpp [0.1 – 297 MHz]
Fault detection condition	None

9.12 331-22-00 SD/HD/3G SDI VIDEO OPTION MODULE

Channel Set Type	SD-SDI, HD-SDI, 3G-SDI
Number of channel sets	2
Changeover Type	HF 3GHz latching relay Retains selected channel set on power fail
Switching Time	Typically <5ms (max <10ms)
Return Loss	<-15dB 5 MHz to 1.5 GHz <-10dB 1.5GHz to 3GHz
Timing Jitter	[100% Colour bars] < 0.20 UIpp [>10Hz] - SD-SDI < 0.30 UIpp [10 Hz-20 kHz] - HD-SDI < 0.60 UIpp [10 Hz-20 kHz] - 3G-SDI
Alignment Jitter	[100% Colour bars] < 0.20 UIpp [1 kHz -27 MHz] < 0.20 UIpp [0.1 -148.5 MHz] < 0.30 UIpp [0.1 – 297 MHz]
Fault detection condition	Error condition <ul style="list-style-type: none"> • No signal detected (carrier detect). • No signal lock Warning condition <ul style="list-style-type: none"> • Cable length detected exceeds the threshold • Format difference detected Format detection as detailed in section 9.13.

9.13 331-22-00 SD/HD/3G SDI VIDEO OPTION MODULE – FORMATS DETECTED AND REPORTED

	Physical	Hactive x Vactive/Frame rate Hz/scan type
3G	SMPTE 425-X	1920x1080/30/sF <i>(note: will be reported as 1920x1080/60/i)</i>
3G	SMPTE 425-X	1920x1080/29.97/sF <i>(note: will be reported as 1920x1080/59.94/i)</i>
3G	SMPTE 425-X	1920x1080/25/sF <i>(note: will be reported as 1920x1080/50/i)</i>
3G	SMPTE 425-X	1920x1080/24/sF <i>(note: will be reported as 1920x1080/48/i)</i>
3G	SMPTE 425-X	1920x1080/23.98/sF <i>(note: will be reported as 1920x1080/47.95/i)</i>
3G	SMPTE 425-X	1920x1080/60/p
3G	SMPTE 425-X	1920x1080/59.94/p
3G	SMPTE 425-X	1920x1080/50/p
3G	SMPTE 425-X	1920x1080/60/i
3G	SMPTE 425-X	1920x1080/59.94/i
3G	SMPTE 425-X	1920x1080/50/i
3G	SMPTE 425-X	1920x1080/30/p
3G	SMPTE 425-X	1920x1080/29.97/p
3G	SMPTE 425-X	1920x1080/25/p
3G	SMPTE 425-X	1920x1080/24/p
3G	SMPTE 425-X	1920x1080/23.98/p
HD	SMPTE 292	1920x1080/30/sF <i>(note: will be reported as 1920x1080/60/i)</i>
HD	SMPTE 292	1920x1080/29.97/sF <i>(note: will be reported as 1920x1080/59.94/i)</i>
HD	SMPTE 292	1920x1080/25/sF <i>(note: will be reported as 1920x1080/50/i)</i>
HD	SMPTE 292	1920x1080/24/sF <i>(note: will be reported as 1920x1080/48/i)</i>
HD	SMPTE 292	1920x1080/23.98/sF <i>(note: will be reported as 1920x1080/47.95/i)</i>
HD	SMPTE 292	1920x1080/60/i
HD	SMPTE 292	1920x1080/59.94/i
HD	SMPTE 292	1920x1080/50/i
HD	SMPTE 292	1920x1080/30/p
HD	SMPTE 292	1920x1080/29.97/p
HD	SMPTE 292	1920x1080/25/p
HD	SMPTE 292	1920x1080/24/p
HD	SMPTE 292	1920x1080/23.98/p
HD	SMPTE 292	1920x1035/59.94/i
HD	SMPTE 292	1920x1035/60/i
HD	SMPTE 292	1280x720/60/p
HD	SMPTE 292	1280x720/59.94/p
HD	SMPTE 292	1280x720/50/p
HD	SMPTE 292	1280x720/30/p
HD	SMPTE 292	1280x720/29.97/p
HD	SMPTE 292	1280x720/25/p
HD	SMPTE 292	1280x720/24/p
SD	SMPTE 292	1280x720/23.98/p
SD	SMPTE 259-C	720x576/50/i
SD	SMPTE 259-C	720x486/59.94/i